



Autodesk® Nastran® In-CAD

What's New



Moment Loads on Solid Element Faces

- Solid elements lack rotational degrees of freedom
- Applying rotations directly would have no effect
- Automatically calculate equivalent load to be applied

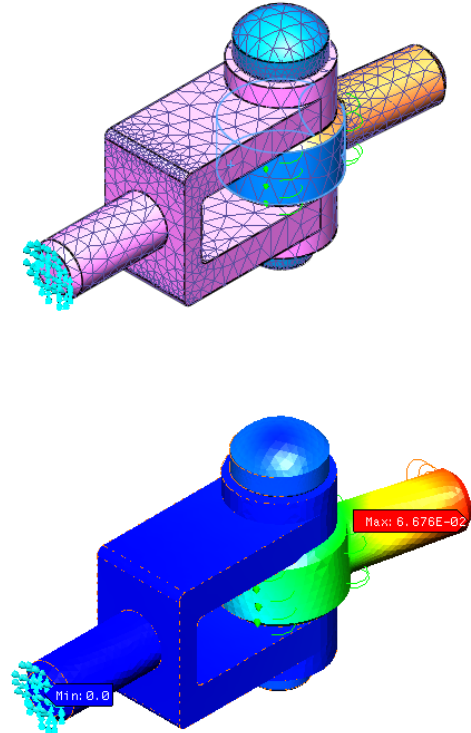
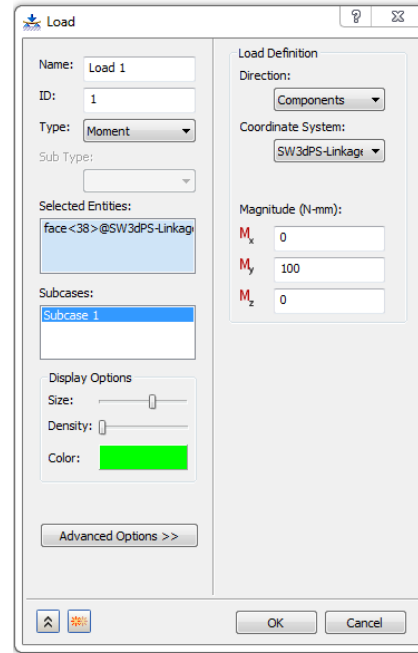

Remote Force Load

- Load can be applied anywhere in the model
- Not restricted to geometric entities
- Force is calculated and applied directly

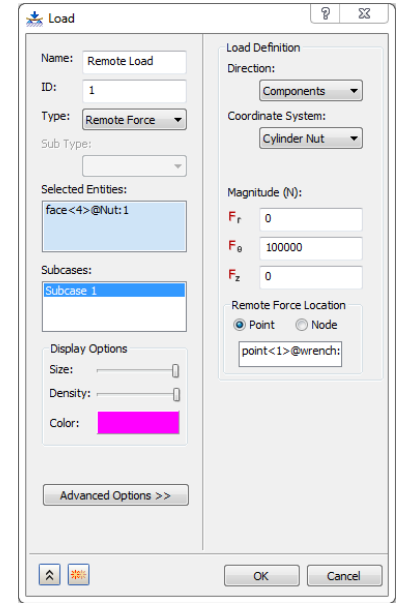
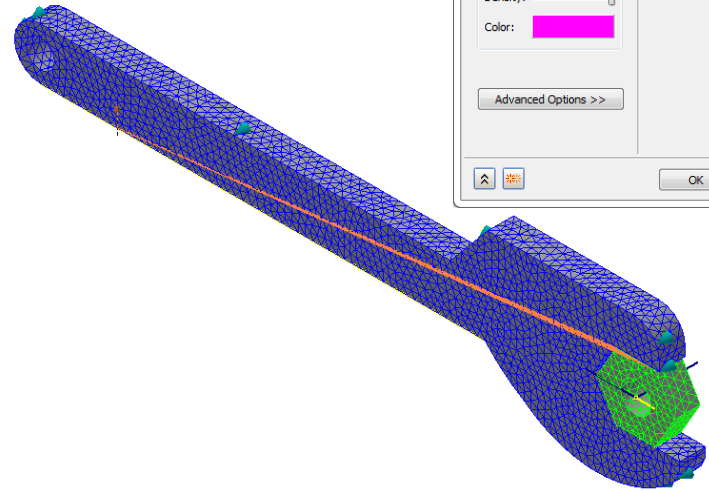

Automatic Contact

- Now supported for geometry
- Tolerance stored under Analysis

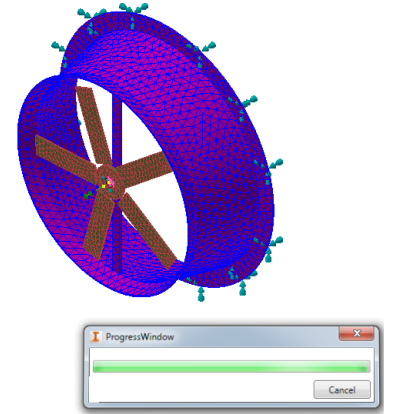
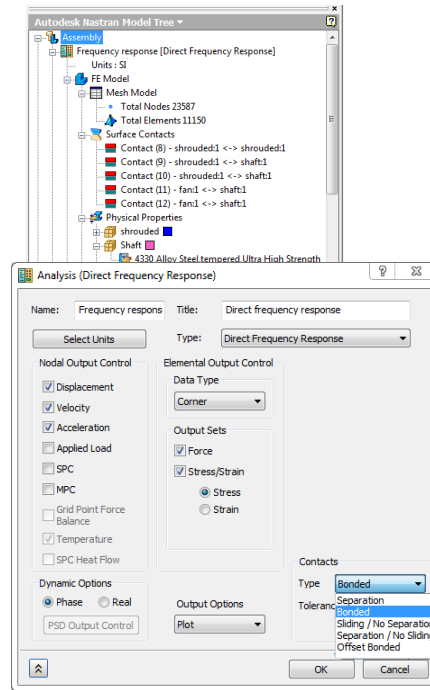

Improved Meshing Progress Bar

- Tracks how far along in the mesh progress
- Mesh outer surface first
- Grow solid elements from there

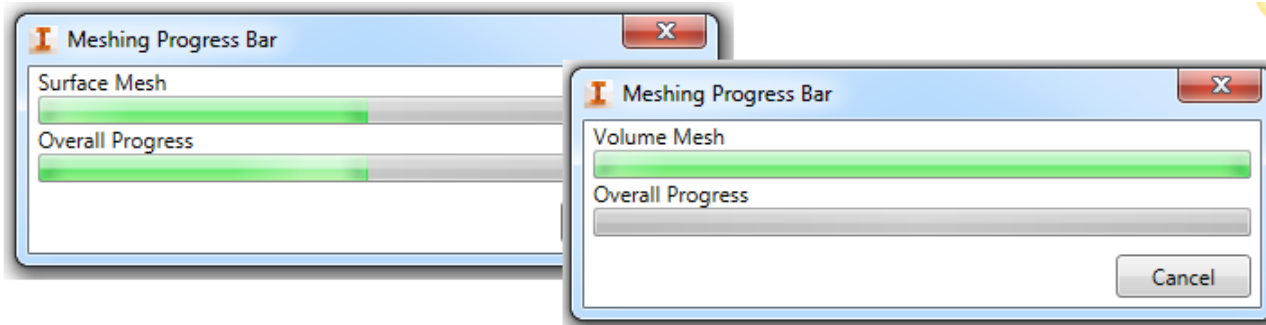

XY Plot Improvements

- Added ability to plot vs. node location
- Results data is now filtered based on node/element selection

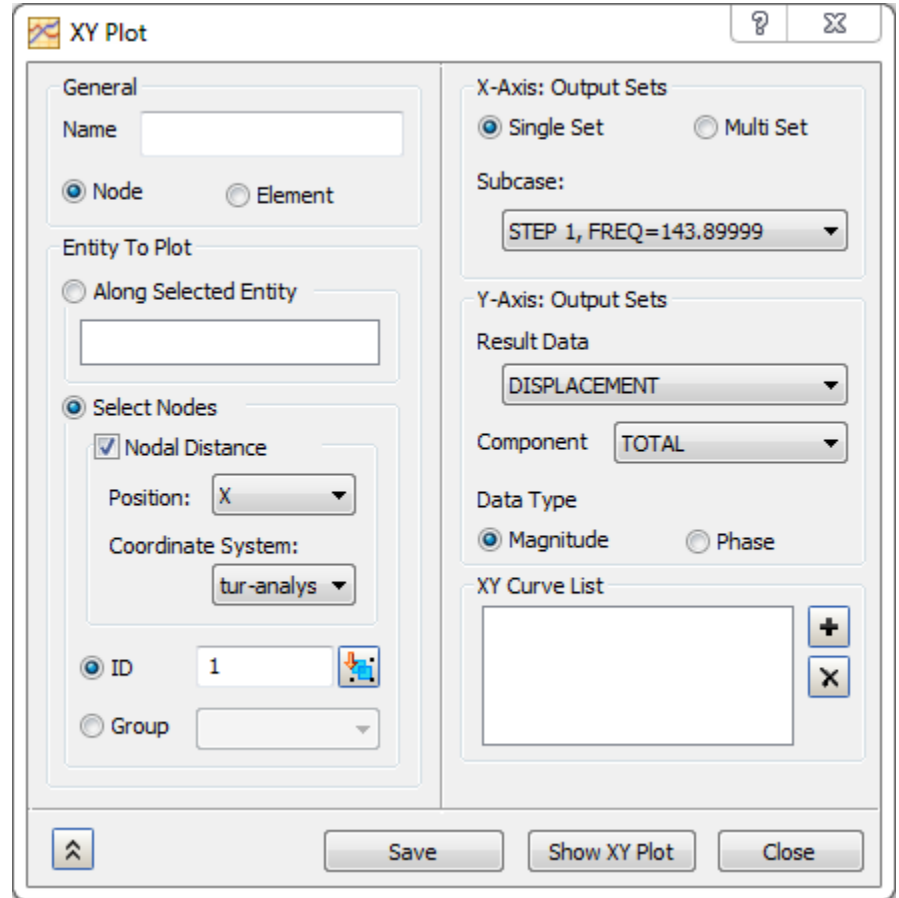

Selection Filter for Geometry

- Can filter between faces, edges, and vertices
- Right-click in dialog for Selected Entities

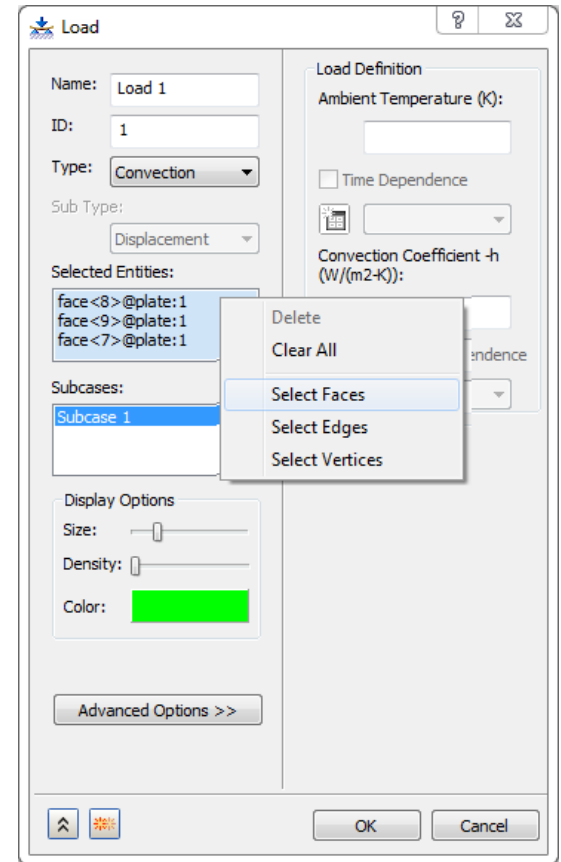

Environment Support for In-CAD

- SP1 moved from add-in to Environment
- Improve performance

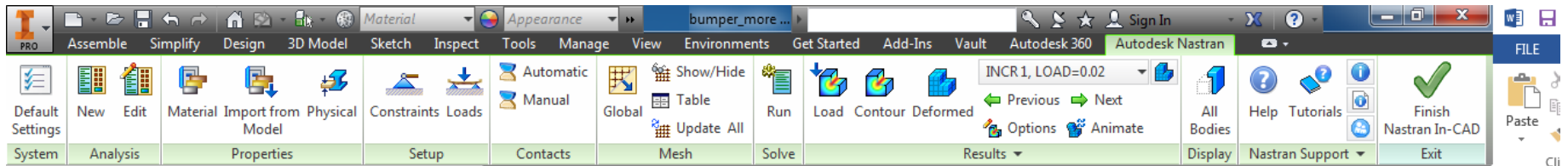

Results Probing

- Probe functionality added to ribbon
- Works when results are loaded
- Can interrogate results in the model

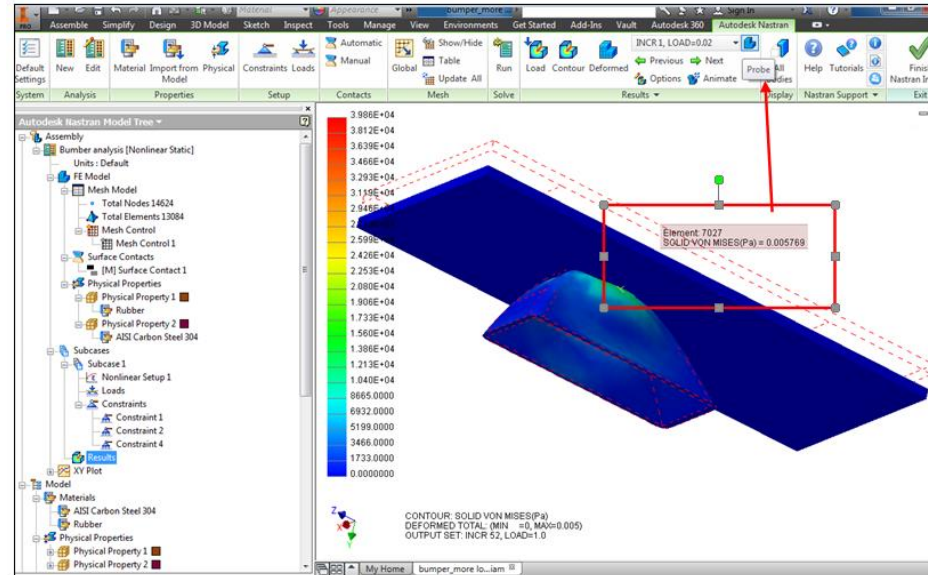

Results Loading

- By default results are not loaded automatically when entering/exiting the environment
- New option to allow for automatic results loading

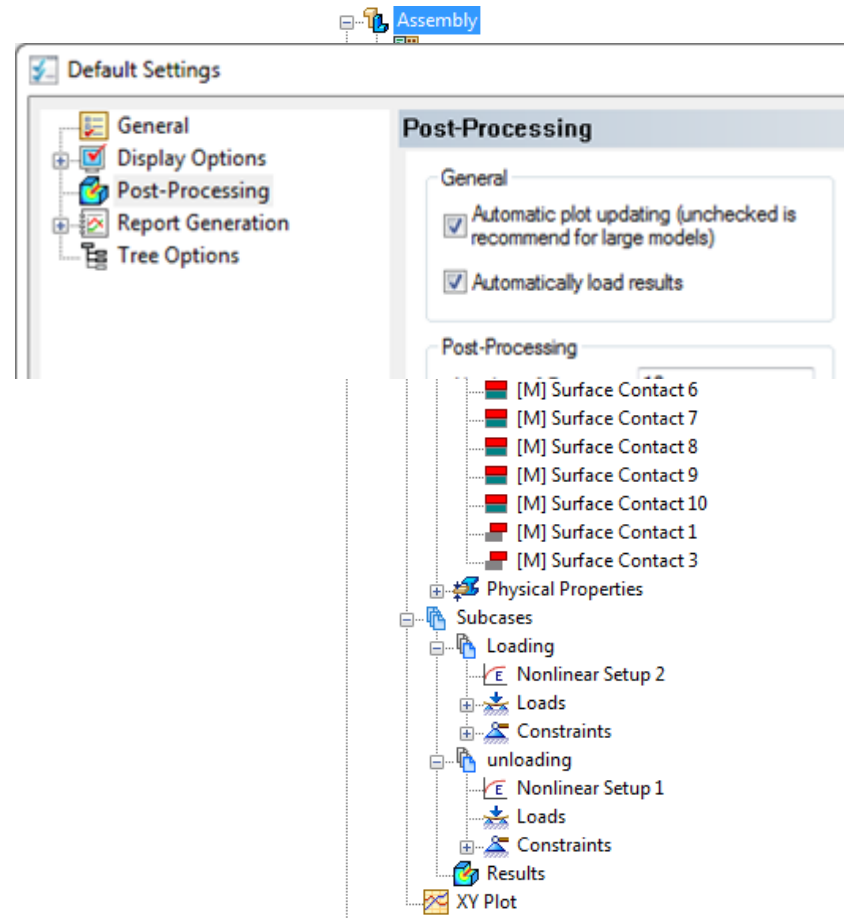

Units

- Double clicking Units in tree will launch Units dialog
- Default units will inherit unit settings from CAD system
- Changing units setting will override

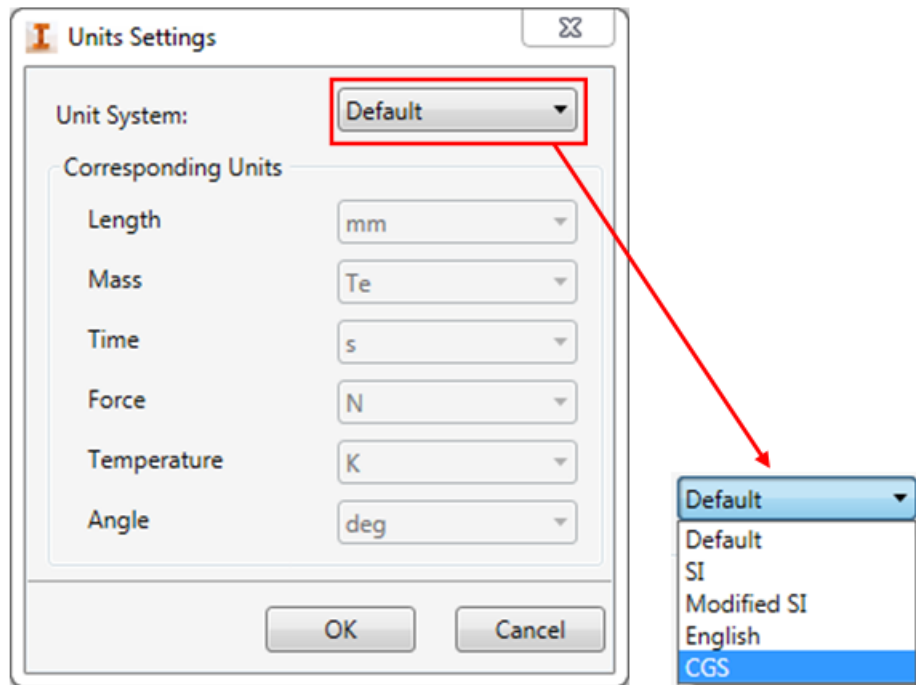

Updated Contact Terminology

- Updated contact terminology to be more consistent with Inventor
- Hover text will show Nastran terminology

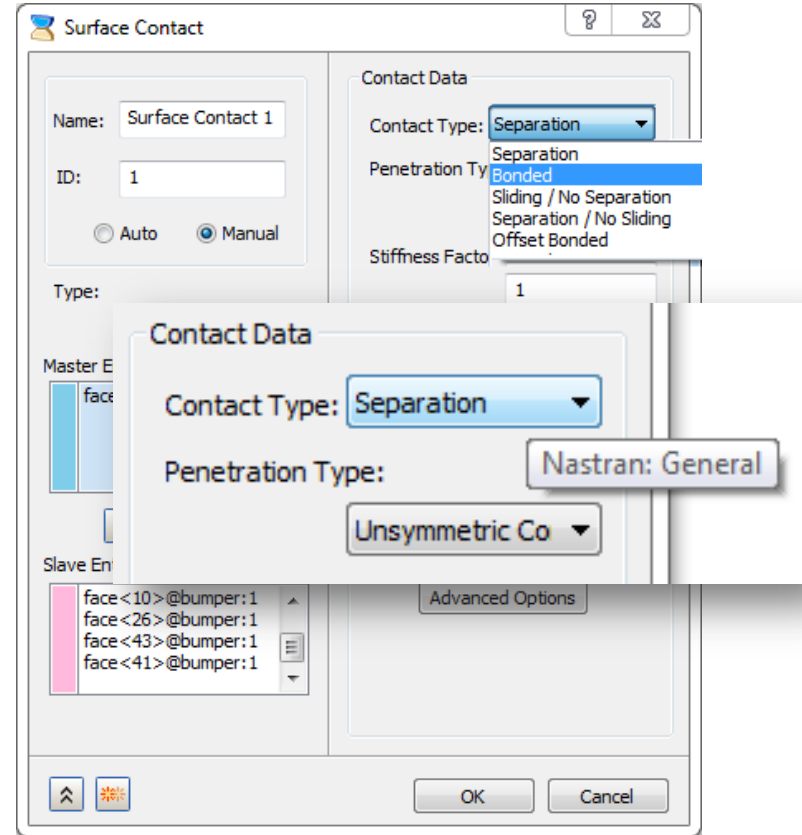

Easy access material library

- Material databases are automatically loaded
- Can use existing libraries or import your own

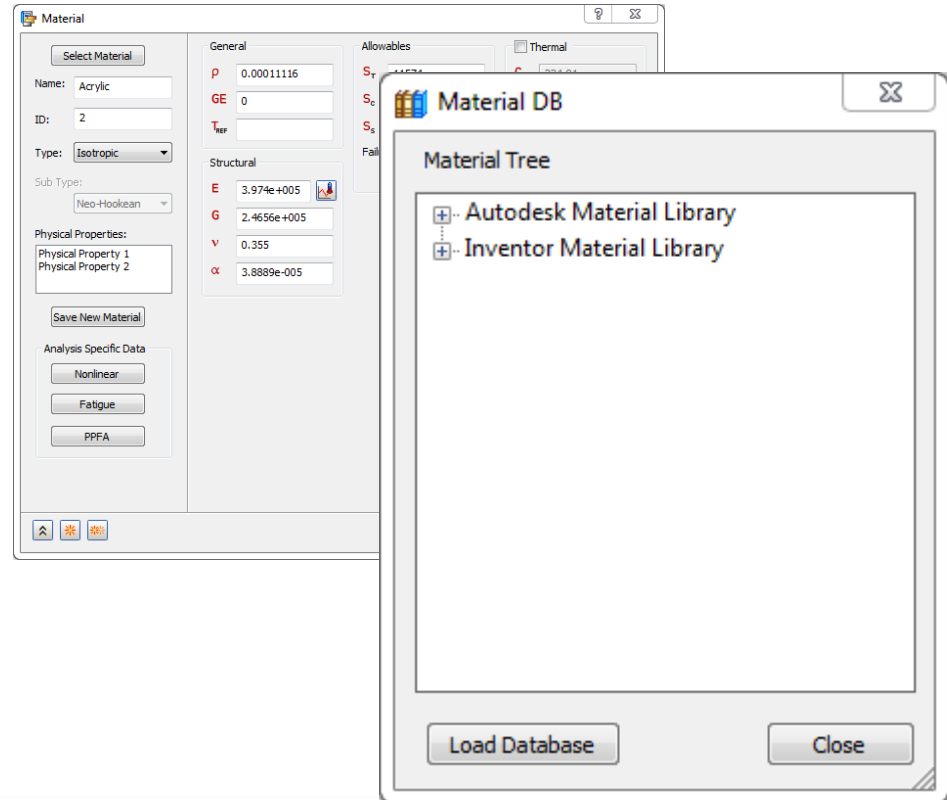

Factor of Safety Output

- New default template for factor of safety
- Scale is automatically reversed to show lowest factor of safety in red

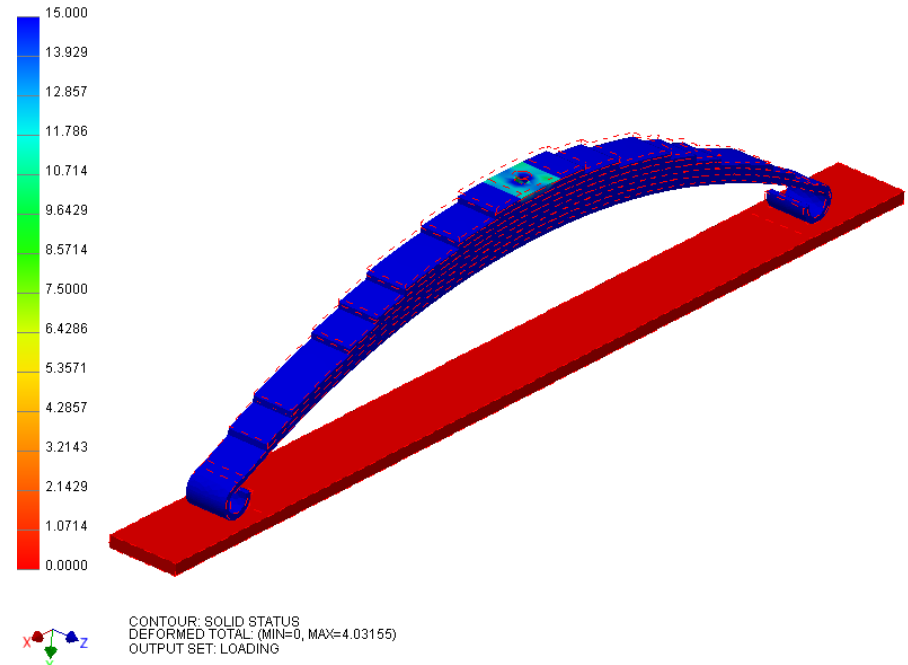



Autodesk, the Autodesk logo, Autodesk Inventor, and Inventor are registered trademarks or trademarks of Autodesk, Inc., and/or its subsidiaries and/or affiliates in the USA and/or other countries. Nastran is a registered trademark of the National Aeronautics and Space Administration. All other brand names, product names, or trademarks belong to their respective holders. Autodesk reserves the right to alter product and services offerings, and specifications and pricing at any time without notice, and is not responsible for typographical or graphical errors that may appear in this document.

© 2015 Autodesk, Inc. All rights reserved.